

# Z-POWER LED Series

## Technical Datasheet for X92050



Z-Power series is designed for high current operation and high flux output applications. Furthermore, its thermal management characteristic is better than other LED Solutions. By package SMD design and good thermal emission material.

According to these advantages, it enables to apply various lighting applications and design solution, automotive lighting, and large size LCD backlight etc.

### Features

- Super high Flux output and high Luminance
- Designed for high current operation
- Low thermal resistance
- SMT solderability
- Lead Free product
- RoHS compliant

### Application

- Mobile phone flash
- Automotive interior / exterior lighting
- Automotive signal lighting
- Automotive forward lighting
- General Torch
- Architectural lighting
- LCD TV / Monitor Backlight
- Projector light source
- Traffic signals
- Task lighting
- Decorative / Pathway lighting
- Remote / Solar powered lighting
- Household appliances

\*The appearance and specifications of the product may be changed for improvement without notice.



## Full Code of Z-Power LED Series

Full code form :  $X_1 X_2 X_3 X_4 X_5 X_6 - X_7 X_8 - X_9 X_{10} X_{11} X_{12} X_{13}$

### 1. Part Number

- $X_1$  : Color
- $X_2$  : Z-Power LED series number
- $X_3$  : LENS type
- $X_4$  : Chip quantity or Watt
- $X_5$  : Package outline size
- $X_6$  : Type of PCB

### 2. Internal Number

- $X_7$
- $X_8$

### 3. Code Labeling

- $X_9$  : Luminous flux (or Radiant flux for royal blue)
- $X_{10} X_{11} X_{12}$  : Dominant wavelength (or x,y coordinates rank code)
- $X_{13}$  : Forward voltage

### 4. Sticker Diagram on Reel & Aluminum Vinyl Bag

PART NO. :  $X_1 X_2 X_3 X_4 X_5 X_6 - X_7 X_8$   
[Barcode]  
QUANTITY : ###  
[Barcode]  
LOT NUMBER : #####  
[Barcode]  
BIN CODE :  $X_9 X_{10} X_{11} X_{12} X_{13}$   
[Barcode]



For more information about binning and labeling, refer to the Application Note -1

## Outline Dimensions

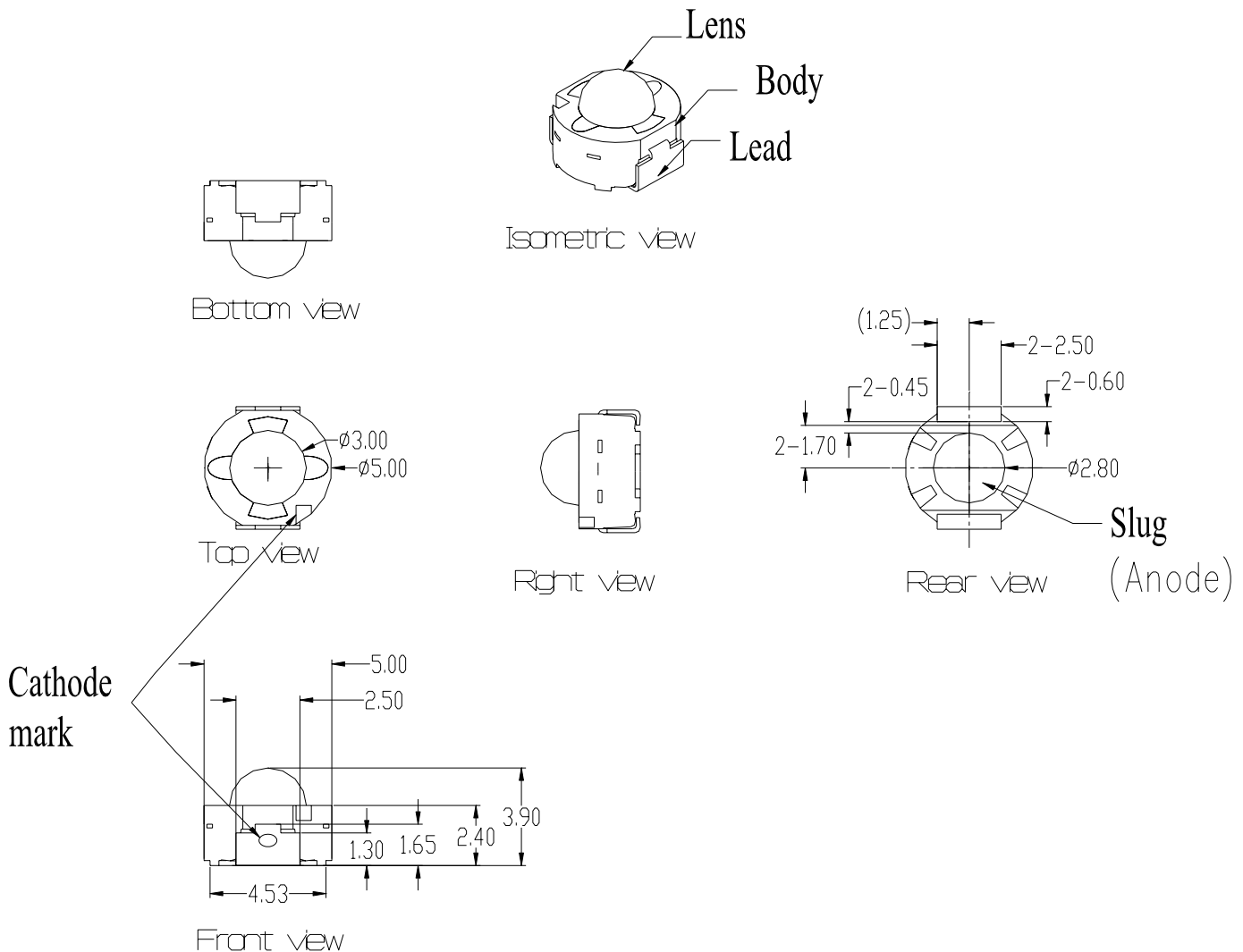

### Notes :

1. View Angle: Wide(typ 140°)
2. All dimensions are in millimeters.
3. Scale : none
4. This drawing without tolerances are for reference only
5. Slug of package is connected to anode.

## Characteristics for Z-Power LED

### 1. Pure White (W92050)

1-1 Electro-Optical characteristics at  $I_F=150\text{mA}$ ,  $T_A=25^\circ\text{C}$

Parameter	Symbol	Value			Unit
		Min	Typ	Max	
Luminous Flux <sup>[1]</sup>	$\Phi_V$ <sup>[2]</sup>	-	25	-	lm
Correlated Color Temperature <sup>[3]</sup>	CCT	-	6500	-	K
CRI	$R_a$	-	70	-	-
Forward Voltage <sup>[4]</sup>	$V_F$	3.0	3.5	3.8	V
View Angle	2 1/2	Wide( typ 140)			deg.
Thermal resistance <sup>[5]</sup>	$R\theta$	21			$^\circ\text{C}/\text{W}$

1-2 Absolute Maximum Ratings

Parameter	Symbol	Value	Unit
Forward Current	$I_F$	0.2	A
Power Dissipation	$P_D$	0.7	W
Junction Temperature	$T_j$	125	$^\circ\text{C}$
Operating Temperature	$T_{opr}$	-30 ~ +85	$^\circ\text{C}$
Storage Temperature	$T_{stg}$	-40 ~ +120	$^\circ\text{C}$
ESD Sensitivity <sup>[6]</sup>	-	$\pm 15,000\text{V HBM}$	-

\*Notes :

[1] SSC maintains a tolerance of  $\pm 10\%$  on flux and power measurements.

[2]  $\Phi_V$  is the total luminous flux output as measured with an integrating sphere.

[3] CCT  $\pm 5\%$  tester tolerance

[4] A tolerance of  $\pm 0.06\text{V}$  on forward voltage measurements

[5]  $R\theta$  is measured with a SSC metal core pcb. ( $25^\circ\text{C} \leq T_j \leq 110^\circ\text{C}$ )

Break voltage of Metal PCB is 6.5kVAC

[6] It is included the zener chip to protect the product from ESD.

\* Caution

**1. Please do not drive at rated current more than 5 sec. without proper heat sink**



## Characteristics for Z-Power LED

### 2. Warm White (N92050)

2-1 Electro-Optical characteristics at  $I_F=150\text{mA}$ ,  $T_A=25^\circ\text{C}$

Parameter	Symbol	Value			Unit
		Min	Typ	Max	
Luminous Flux <sup>[1]</sup>	$\Phi_V$ <sup>[2]</sup>	-	15	-	lm
Correlated Color Temperature <sup>[3]</sup>	CCT	-	3000	-	K
CRI	$R_a$	75	80	-	-
Forward Voltage <sup>[4]</sup>	$V_F$	3.0	3.5	3.8	V
View Angle	2 1/2	Wide(typ 140)			deg.
Thermal resistance <sup>[5]</sup>	$R\theta$	21			$^\circ\text{C}/\text{W}$

2-2 Absolute Maximum Ratings

Parameter	Symbol	Value	Unit
Forward Current	$I_F$	0.2	A
Power Dissipation	$P_D$	0.7	W
Junction Temperature	$T_j$	125	$^\circ\text{C}$
Operating Temperature	$T_{opr}$	-30 ~ +85	$^\circ\text{C}$
Storage Temperature	$T_{stg}$	-40 ~ +120	$^\circ\text{C}$
ESD Sensitivity <sup>[6]</sup>	-	$\pm 15,000\text{V HBM}$	-

\*Notes :

- [1] SSC maintains a tolerance of  $\pm 10\%$  on flux and power measurements.
- [2]  $\Phi_V$  is the total luminous flux output as measured with an integrating sphere.
- [3] CCT  $\pm 5\%$  tester tolerance
- [4] A tolerance of  $\pm 0.06\text{V}$  on forward voltage measurements
- [5]  $R\theta$  is measured with a SSC metal core pcb. ( $25^\circ\text{C} \leq T_j \leq 110^\circ\text{C}$ )  
Break voltage of Metal PCB is 6.5kVAC
- [6] It is included the zener chip to protect the product from ESD.

\* Caution

1. Please do not drive at rated current more than 5 sec. without proper heat sink



### 1. Pure White

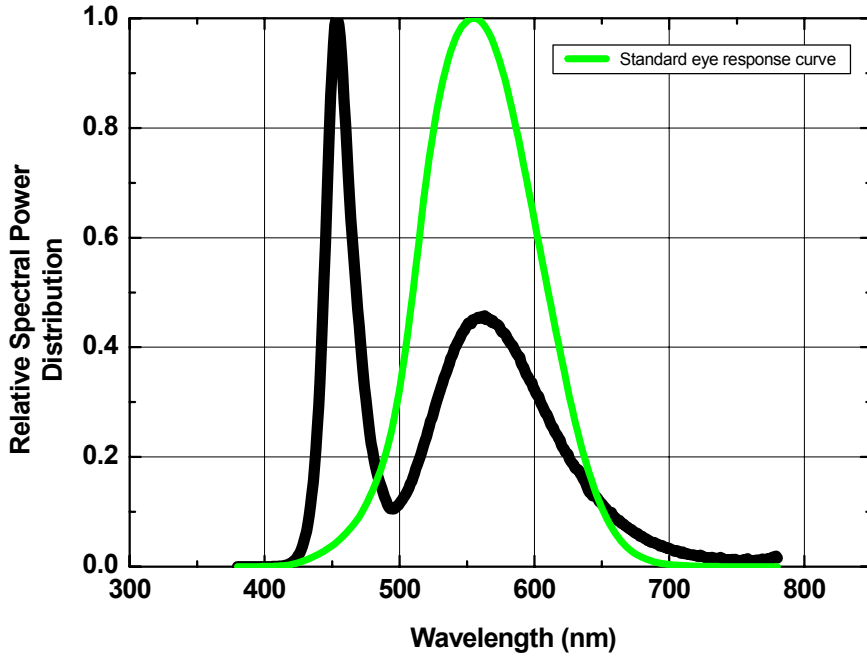

### 2. Warm White

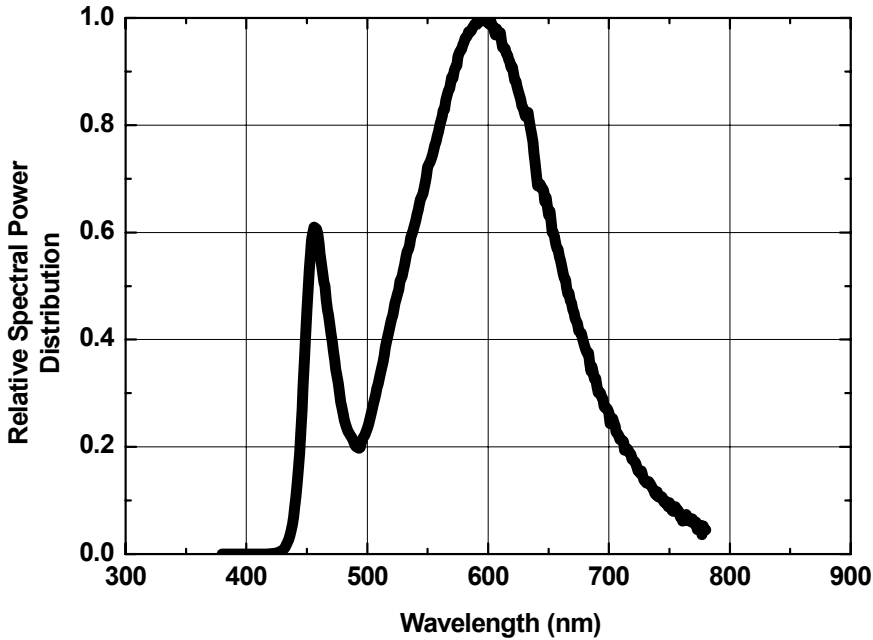

## Light Output Characteristics

### 1. Relative Light Output vs. Junction Temperature at $T_A=25$

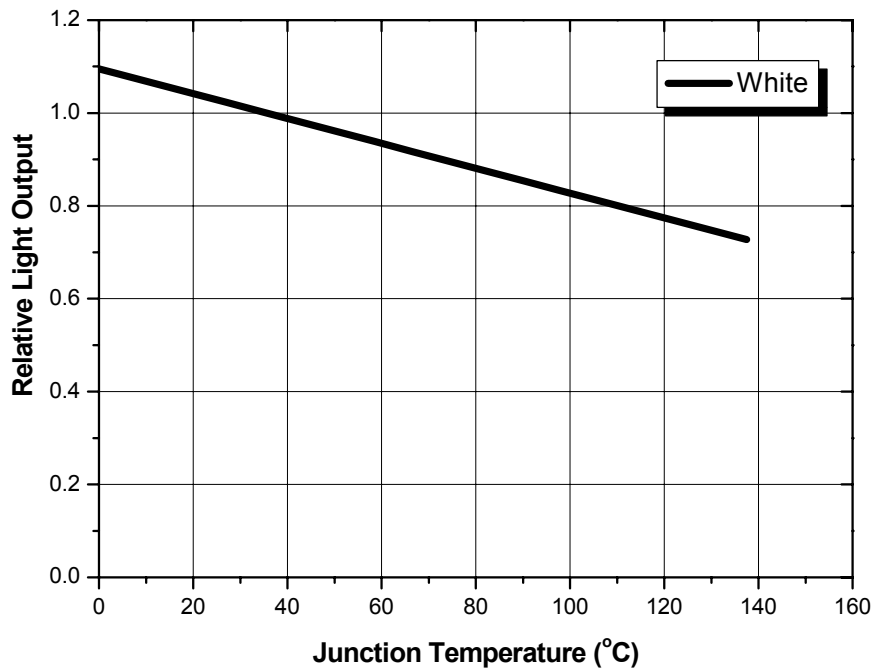

## Forward Current Characteristics

### 1. Forward Voltage vs. Forward Current, $T_A=25$

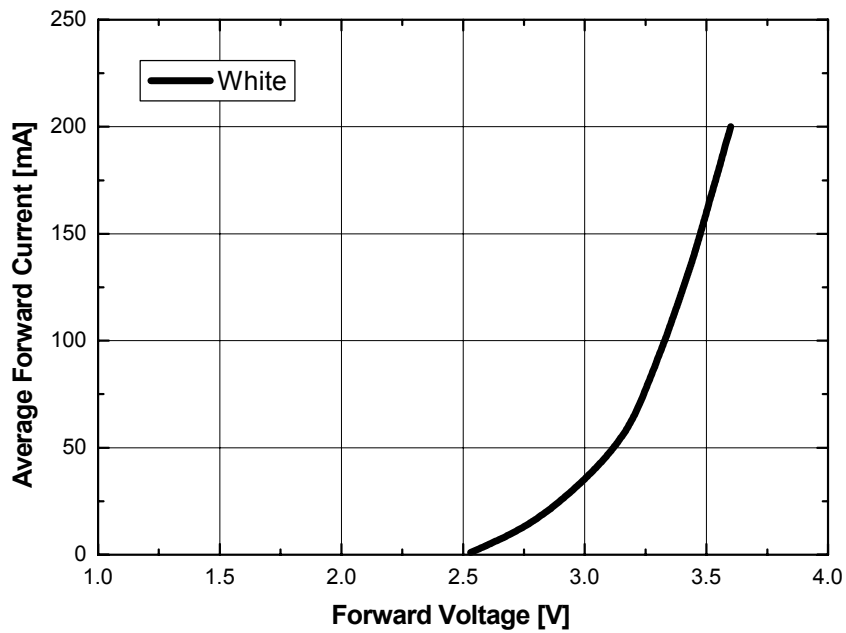

### 2. Forward Current vs. Normalized Relative Luminous Flux, $T_A=25$

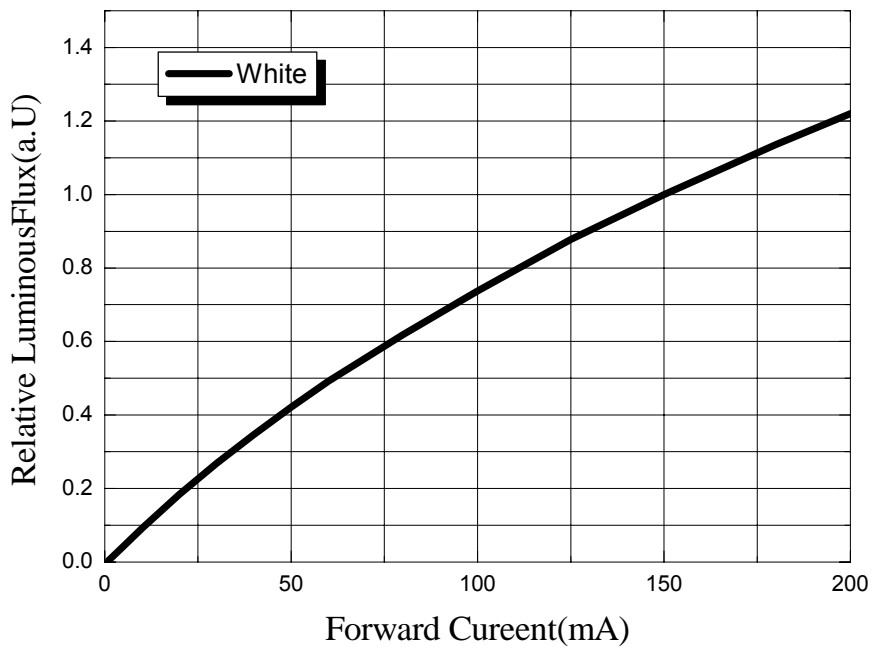



## Ambient Temperature vs Allowable Forward Current

### 1. Pure White, Warm White ( $T_{JMAX} = 125\text{ }^{\circ}\text{C}$ )

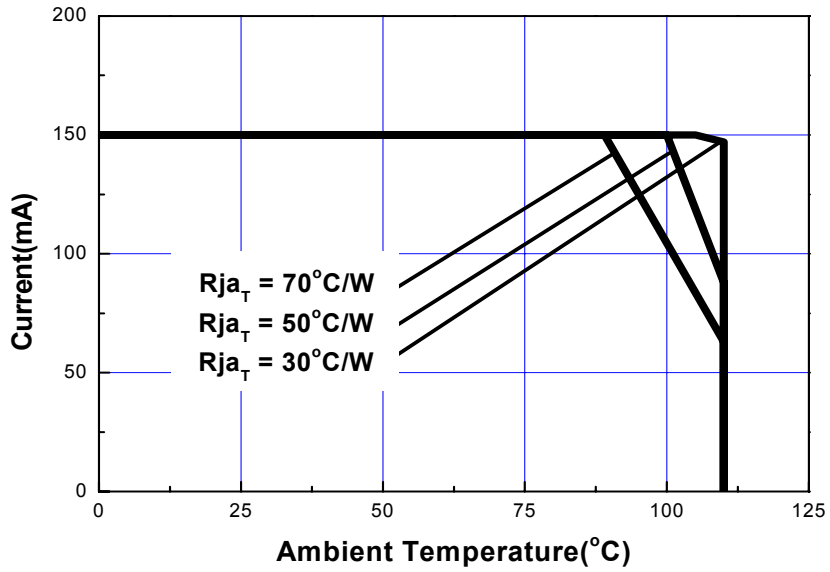

## Typical Dome Type Radiation pattern

### 1. Pure White, Warm White

-Wide(Typ 140)

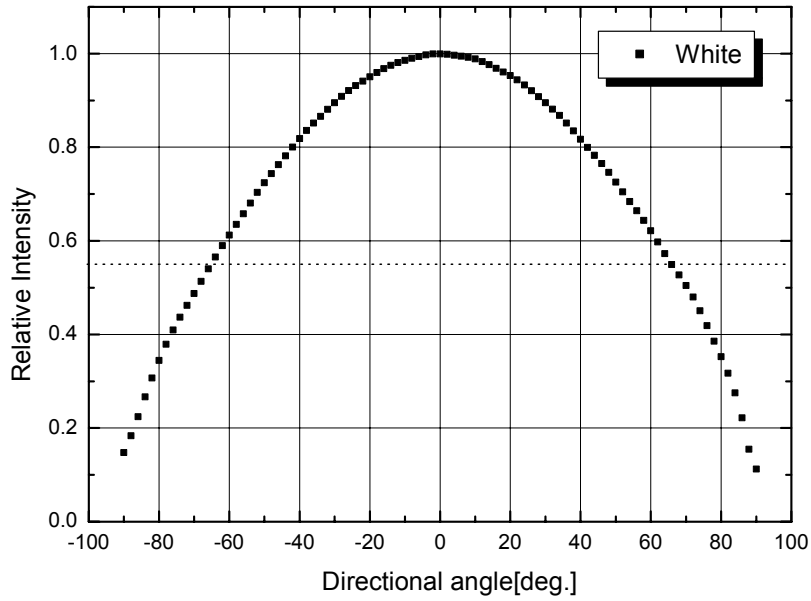

## Recommended Solder pad

### 1. Solder pad

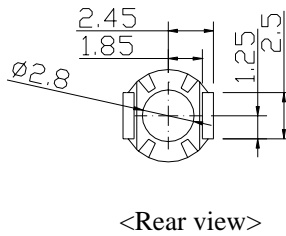
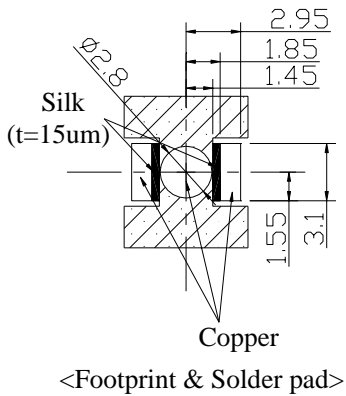
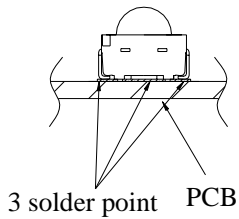

### 2. Solder paste pattern

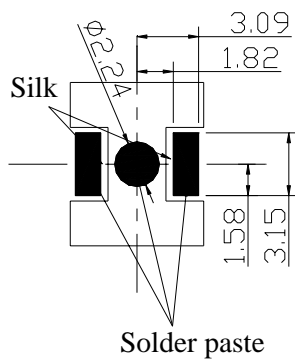

Paste thickness : 0.2mm

Note :

1. All dimensions are in millimeters
2. Scale none
3. This drawing without tolerances are for reference only

## Soldering profile, $T_A=25^\circ\text{C}$

### 1. Reflow Soldering Conditions / Profile

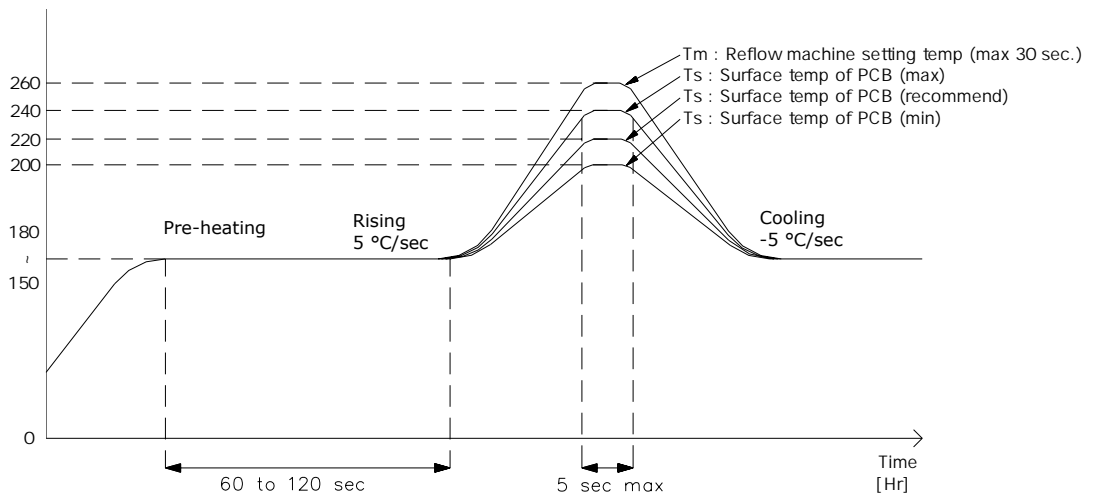

### 2. Hand Soldering conditions

Lead : Not more than 3 seconds @MAX280  
Slug : Use a thermal-adhesives

#### \* Caution

1. Reflow soldering should not be done more than one time.
2. Repairing should not be done after the LEDs have been soldered. When repairing is unavoidable, suitable tools have to be used.
3. Die slug is to be soldered.
4. When soldering, do not put stress on the LEDs during heating.
5. After soldering, do not warp the circuit board.
6. Recommend to use a convection type reflow machine with 7 ~ 8 zones.

# Rectangular Type Reel Packaging –W92050

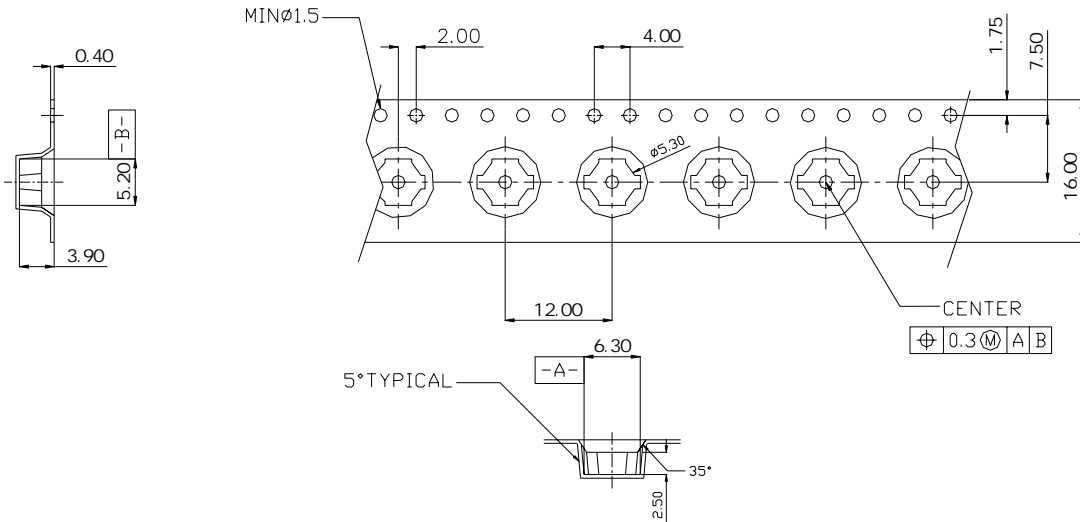
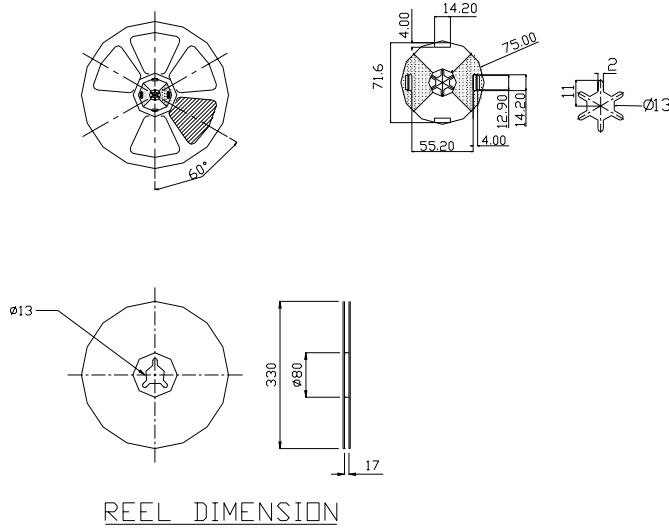

Note :

1. The number of loaded products in the reel is 500ea
2. All dimensions are in millimeters
3. Scale none

\*The appearance and specifications of the product may be changed for improvement without notice.

## Precaution for use

- Storage  
Avoid the absorption of moisture, we recommended to store Z Power LEDs in a dry box (or desiccator) with a desiccant . Otherwise, store them in the following environment:  
Temperature : 5℃~30℃ Humidity : 50% max.
- Precaution after opening packaging  
However LED is correspond SMD, when LED be soldered dip, interfacial separation may affect the light transmission efficiency, causing the light intensity to drop.  
Attention in followed.
  - a. Soldering should be done right after opening the package(within 24Hrs).
  - b. Keeping of a fraction
    - Sealing
    - Temperature : 5 ~ 40℃ Humidity : less than 30%
  - c. If the package has been opened more than 1week or the color of desiccant changes, components should be dried for 10-12hr at 60±5℃
- Any mechanical force or any excess vibration shall not be accepted to apply during cooling process to normal temp. after soldering.
- Avoid quick cooling
- Components should not be mounted on warped direction of PCB.
- Anti radioactive ray design is not considered for the products listed here in.
- Gallium arsenide is used in some of the products listed in this publication. These products are dangerous if they are burned or smashed in the process of disposal. It is also dangerous to drink the liquid or inhale the gas generated by such products when chemically disposed.
- This device should not be used in any type of fluid such as water, oil, organic solvent and etc. When washing is required, IPA(Isopropyl Alcohol) should be used.
- When the LEDs are illuminating, operating current should be decided after considering the package maximum temperature.
- LEDs must be stored to maintain a clean atmosphere. If the LEDs are stored for 3 months or more after being shipped from SSC, a sealed container with a nitrogen atmosphere should be used for storage.
- The appearance and specifications of the product may be modified for improvement without notice.
- Long time exposure of sunlight or occasional UV exposure will cause lens discoloration.
- Slug polarity is anode.

---

## Handling of Silicone resin LEDs

Z-Power LED is encapsulated by silicone resin for the highest flux efficiency.

Notes for handling of Silicone resin Z-Power LEDs

- Avoid touching silicone resin parts especially by sharp tools such as Pincette(Tweezers)
- Avoid leaving fingerprints on silicone resin parts.
- Dust sensitivity silicone resin need containers having cover for storage.
- When populating boards in SMT production, there are basically no restrictions regarding the form of the pick and place nozzle, except that mechanical pressure on the surface of the resin must be prevent.
- Please do not force over 1500 gf impact or pressure diagonally on the silicon lens. It will cause fatal damage of this product
- Please do not recommend to cover the silicone resin of the LEDs with other resin (epoxy, urethane, etc)